



The Huck  
Product Range®

BobTail®

### BobTail® Key Features

- The Huck BobTail® - innovative and unique Lockbolt design with no pin-break, no waste material to collect and dispose of or potential corrosion issues post installation
- Consistent clamp - will not loosen even under extreme vibration
- Tamper proof - one installed cannot easily be removed without specialist tooling
- Unique helical lock-groove
- Maintenance free joints - eliminates checking / replacement and ultimately cost reductions
- Installation indicator on collar for visual inspection
- Easy to learn, shock free, low noise installation
- A viable alternative to welding and nuts and bolts - engineered for easy installation and long, reliable life. Can be a faster, more cost efficient and safer alternative to traditional welding processes.
- Materials: Steel, Aluminum
- Head Styles: Round, Truss, 90° Flush, Flanged, 98T, Trazier



# Huck® BobTail®

## Huck's Next-Generation, Pintail-Less HuckBolt

Representing the most advanced fastening technology to date, the BobTail® delivers the highest level of performance and reliability.

Engineered to meet the challenges of a wide range of assembly applications, BobTail offers safe, quiet, swaged-on installation technology in a unique, pintail-less design. Available in an assortment of sizes, in both Grade 5 and Grade 8. BobTail offers 5 times the fatigue strength of conventional nuts and bolts and unmatched installation speed – often under 2 seconds per fastener.

Its unique no-break-off pintail offers the highest corrosion-resistance in its class, while advanced, low-swage technology enables installation with lightweight, ergonomic tools. When you factor in the cost of fasteners with installation and inspection labor, BobTail often provides an overall lower installed cost.

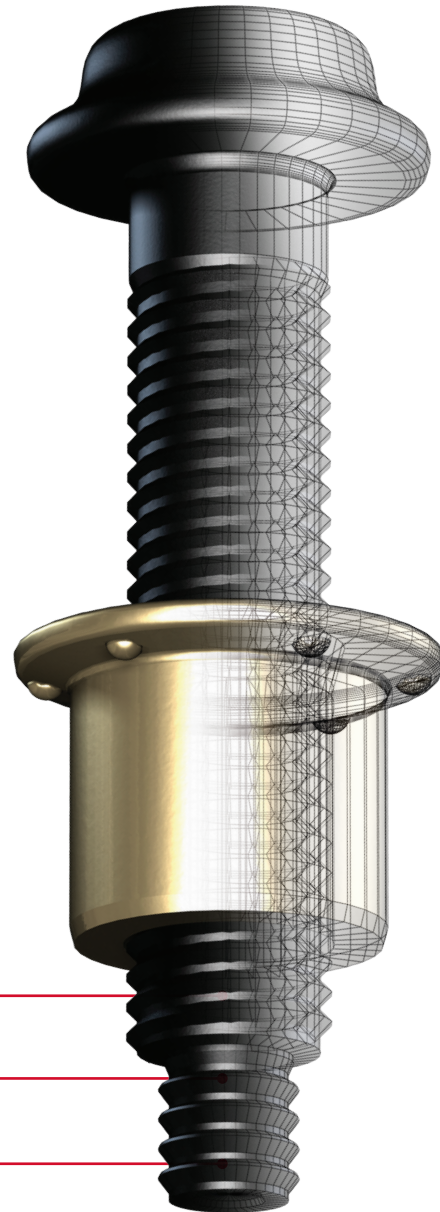

**Available Sizes** 1/2", 5/8", 3/4", 7/8", 1"  
12mm, 14mm, 16mm, 20mm

**Materials** Steel

**Headstyles** Round, Truss, 90° Flush, Flanged, 98T, Trazier

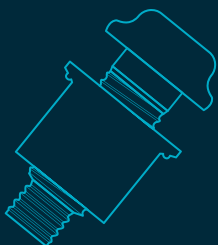

- ✓ No pintail
- ✓ Maintenance Free
- ✓ Low overall installed cost
- ✓ Superior strength (fatigue)
- ✓ Vibration resistance
- ✓ Quiet installation
- ✓ No repetitive stress injuries
- ✓ No special training or skills required for installation personnel
- ✓ Quick visual inspection is all that's needed for a quality-assured joint

## Unmatched Speed of Installation

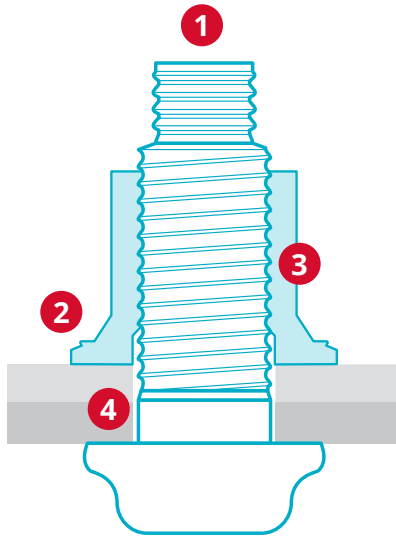

- 1 Pintail-less design means reduced noise, no waste, and improved corrosion resistance.
- 2 Visual evidence of successful installation provided by installation indicator.
- 3 Collar material swaged into the lockgrooves forms a permanent, vibration-resistant connection.
- 4 Low-swage technology allows for faster, lighter, ergonomic tooling with parts that last longer.

**For Oversized Holes:** To optimize clamp, hardened washers such as ASTM F436, DIN 6916 or EN 14399-6 are recommended for use with oversize holes and slots, along with good bolting practice.

## Quick, Easy Visual Inspection

Combining an advanced fastener design with the latest in easy-to-use, ergonomic installation tooling, the BobTail system delivers a strong connection and sets a new standard for ease of installation.



“Dots” on the BobTail collar indicates a full swage when at least one is crossed by the swage anvil.

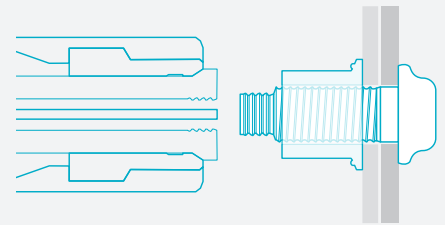

Insert pin into the prepared hole, spin the collar onto the pin.

1

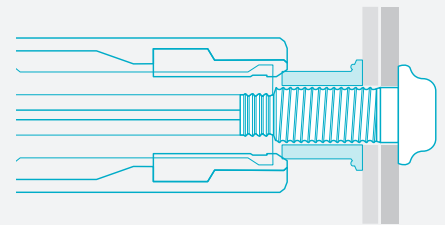

The installation tool is applied to annular pull grooves. When the tool is activated, a puller in the nose assembly draws the pin into the tool, causing the swaging anvil to press on the collar, drawing up any sheet gap.

2

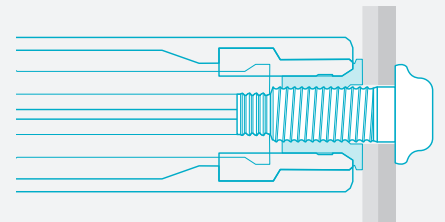

At a predetermined force, the anvil begins to swage the collar into the pin's lockgrooves. Continued swaging elongates the collar and pin, developing precise clamp.

3

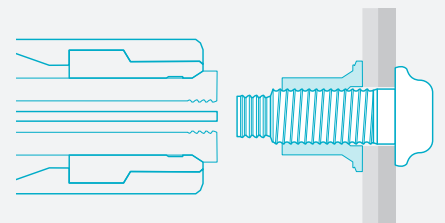

When swaging of the collar into the pin lockgrooves is complete, the tool ejects the fastener and releases the puller to complete the sequence.

4

# BobTail System

Not Just Manufactured. Huck-Engineered

Unlike conventional nuts and bolts, which have gaps on the thread flanks even when tightened, the BobTail system is designed for full metal-to-metal contact around the bolt thread by the collar. An installed BobTail has no gaps and delivers a more secure connection, providing reliability even in the most severe environments.



Increased Life,  
Decreased Maintenance,  
Virtually Vibration Proof

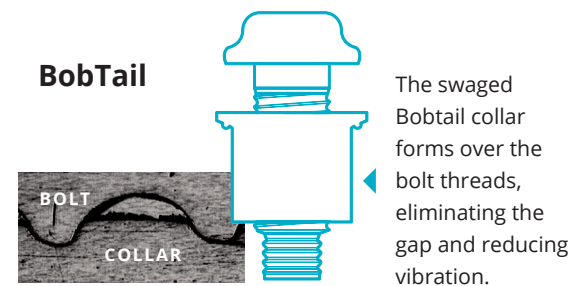
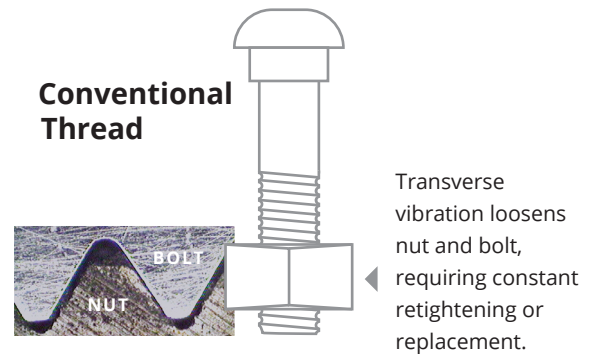
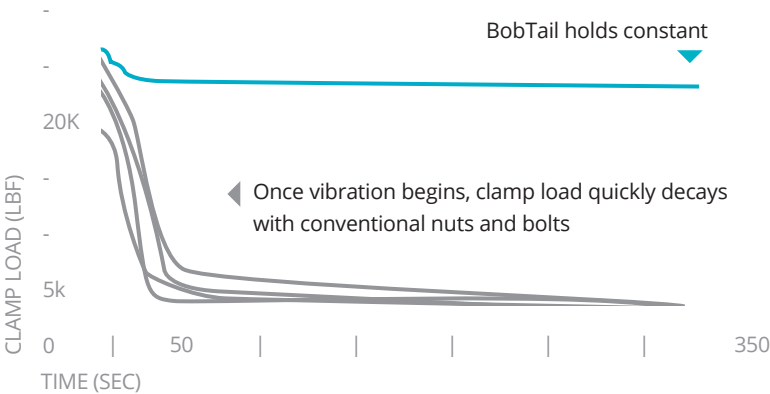

# BOBTAIL® NEXT STEP IN LOCKBOLT EVOLUTION

The Huck BobTail system includes LockBolts and installation tooling that will deliver you benefits beyond anything that Howmet Fastening Systems & Rings Industrial Division has produced before.

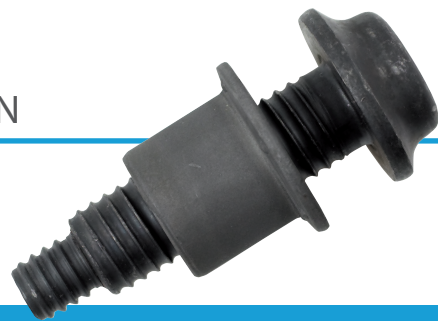

## Key Benefits

### Cycle Installation Speed

Speed of fastener installation has to be seen to be believed with the 1/4 diameter BobTail fastener installing in less than 1 second. The 16mm diameter BobTail fastener installs in 2 seconds, up to twice as fast as any large diameter LockBolt on the market.

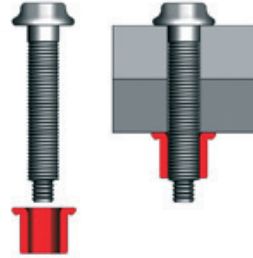

### No pin-tail or pin-break

- No material waste
- Low installation noise
- Increased corrosion resistance

### Smooth, shock free installation sequence

- Eliminates jolts to the operator's arms and hands

### Unique helical lock groove (12mm diameter upwards)

- Holds pin and collar in place prior to installation

### High Fatigue Strength Thread Form

Shallow thread and large root radius increase fatigue strength



Hardened Pin

Softer collar material flows between lock-grooves

### Installation indicator on collar for visual inspection (12mm diameter upwards)

The swage indicators indent when installation is complete



Prior to Installation



After Installation



Huck BobTail has gained the prestigious German national technical approval from DIBt.

### Combined with all the benefits of using a Huck LockBolt

- Permanent, mechanically locked fastener:
  - Installation process automatically provides fastener values
  - No torque or re-torque required
- Unlike conventional nuts and bolts, they will not work loose, even during extreme vibration
- Easy visual inspection ensures correct installation

### Convert from other Huck LockBolts to BobTail

If you are currently using Huck C50L or C6L Lockbolts then due to the dimensional and strength similarities it is quick and easy to switch BobTail to gain the extra benefits listed above\*.

### Consistent Clamp with BobTail

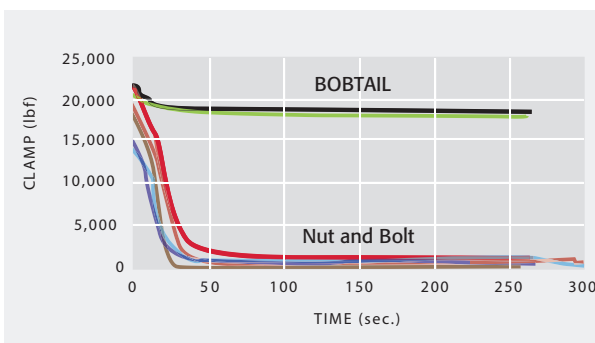

This chart shows nut and bolt clamp scatter is much wider compared to Bobtail, and that once vibration begins, clamp load quickly decays with conventional nuts and bolts, while it holds constant with the Bobtail.

\*Some installation tooling adaptation will be needed.

## Uninstalled Dimensions

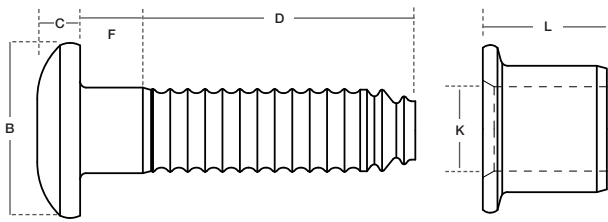

**Head Style:** Round, Truss Head

**Material:** Carbon Steel

*Other head styles and materials available on request.*

## Grip Range and Length Table

Grip Number	Grip Range		6,4mm (1/4")	6,4mm (1/4")	7,9mm (5/16")	7,9mm (5/16")	9,5mm (3/8")	9,5mm (3/8")
	From (mm)	to (mm)	D Max (mm)	F Nominal (mm)	D Max (mm)	F Nominal (mm)	D Max (mm)	F Nominal (mm)
1	0.0	4.7	20.7	1.0				
2	0.0	6.4	22.2	1.6				
3	1.6	7.9	23.8	3.2				
4	3.2	9.5	25.4	4.7	29.4	4.7	33.3	4.8
5	4.7	11.1	27.0	6.4				
6	6.4	12.7	28.6	7.9	32.5	7.9	36.5	7.9
8	9.5	15.9	30.2	11.1	35.7	11.1	39.6	11.1
10	12.7	19.1	31.8	14.3	38.9	14.3	42.8	14.3
12	15.9	22.2	33.3	17.4	42.1	17.4	46.0	17.5
14	19.1	25.4	34.9	20.6	45.2	20.6	49.1	20.6
16	22.2	28.6	36.5	23.8	48.4	23.8	52.3	23.8
18	25.4	31.8	38.1	27.0	51.6	27.0	55.5	27.0
20	28.6	34.9	39.7	30.1	54.8	30.1	58.7	30.2

## Head and Collar Dimension Table

Diameter (mm)	Head Dimensions		Collar Dimensions	
	B Max (mm)	C Max (mm)	K Max (mm)	L Max (mm)
6.4mm (1/4")	13.6	3.6	13.1	9.7
7.9mm (5/16")	17.3	4.4	16.3	12.1
9.5mm (3/8")	20.83	5.3	19.56	14.35

## Installed Dimensions

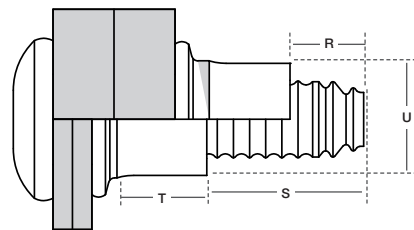

## Installed Information and Max Hole Table

Diameter (mm)	Minimum Installed Strength Values						Installed Dimensions				
	Class 5.8			Class 8.8			R Min (mm)	S Max (mm)	T Min (mm)	U Max (mm)	Max Hole (mm)
	Clamp (kN)	Tensile (kN)	Shear (kN)	Clamp (kN)	Tensile (kN)	Shear (kN)					
6.4mm (1/4")	8.0	13.3	13.6	10.2	16.5	19.1	5.7	13.6	6.6	9.2	7.9
7.9mm (5/16")	12.5	20.5	21.0	18.7	26.7	29.8	7.1	15.2	8.3	11.6	9.9
9.5mm (3/8")	17.9	28.9	30.4	26.6	41.4	42.7	8.8	16.9	9.9	13.8	11.9

# METRIC LARGE DIAMETER BOBTAIL



## Uninstalled Dimensions

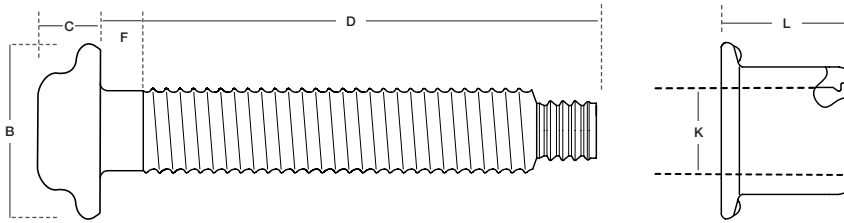

**Head Style:** Flanged

**Material:** Carbon Steel

*Other head styles and materials available on request.*

## Grip Range and Length Table

Grip Number	Grip range		12mm	12mm	14mm	14mm	16mm	16mm	20mm	20mm
	From (mm)	to (mm)	D Max (mm)	F Nominal (mm)	D Max (mm)	F Nominal (mm)	D Max (mm)	F Nominal (mm)	D Max (mm)	F Nominal (mm)
10	5	15	46.1	3.8	49	3.8	52	3.8	60.7	3.8
15	10	20	51.1	3.8	54	3.8	57	3.8	65.7	3.8
20	15	25	56.1	3.8	59	3.8	62	3.8	70.7	3.8
25	20	30	61.1	3.8	64	3.8	67	3.8	75.7	3.8
30	25	35	66.1	3.8	69	3.8	72	3.8	80.7	3.8
35	30	40	71.1	3.8	74	3.8	77	3.8	85.7	3.8
40	35	45	76.1	3.8	79	3.8	82	3.8	90.7	3.8
45	40	50	81.1	3.8	84	3.8	87	3.8	95.7	3.8
50	45	55	86.1	3.8	89	3.8	92	9.5	100.7	3.8
55	50	60	91.1	3.8	94	3.8	97	9.5	105.7	3.8
60	55	65	96.1	3.8	99	3.8	102	9.5	110.7	3.8
65	60	70	101.1	3.8	104	3.8	107	9.5	115.7	9.5
70	65	75	106.1	3.8	109	3.8	112	9.5	120.7	9.5
75	70	80	111.1	3.8	114	9.5	117	9.5	125.7	9.5
80	75	85	116.1	9.5	119	9.5	122	9.5	130.7	9.5

## Head and Collar Dimension Table

Diameter (mm)	Head Dimensions		Collar Dimensions	
	B Max (mm)	C Max (mm)	K Max (mm)	L Max (mm)
12mm	25.4	9.6	12.3	17.9
14mm	30	11.5	14.4	21.5
16mm	33.8	12.2	16.4	23.7
20mm	42.4	16	20.5	29.6

## Installed Dimensions

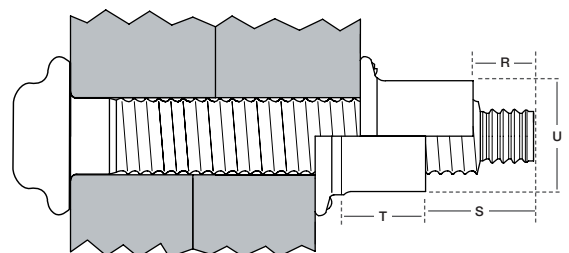

## Installed Information and Max Hole Table

Diameter (mm)	Minimum Installed Strength Values			Installed Dimensions				Max Hole (mm)
	Clamp (kN)	Tensile (kN)	Shear (kN)	R Min (mm)	S Max (mm)	T Min (mm)	U Max (mm)	
12mm	64.9	87.7	65.4	11.1	23.7	13.1	17.3	13.5
14mm	87	120	94	11.2	24.6	15.5	20.2	15.5
16mm	116	163	122	11.2	23.3	17.4	23.1	17.5
20mm	181	255	182	14	28.5	21.8	28.8	22

# IMPERIAL LARGE DIAMETER BOBTAIL



## Uninstalled Dimensions

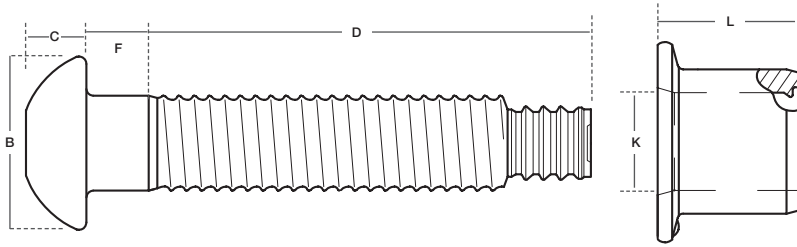

**Head Style:** Round

**Material:** Carbon Steel

*Other head styles and materials available on request.*

## Grip Range and Length Table

Grip Number	Grip Range		12.7mm (1/2")	12.7mm (1/2")	15.9mm (5/8")	15.9mm (5/8")	19.1mm (3/4")	19.1mm (3/4")	22.2mm (7/8")	22.2mm (7/8")	25.4mm (1")	25.4mm (1")
	From (mm)	to (mm)	D Max (mm)	F Nominal (mm)	D Max (mm)	F Nominal (mm)	D Max (mm)	F Nominal (mm)	D Max (mm)	F Nominal (mm)	D Max (mm)	F Nominal (mm)
4	6.4	15.7	48.3	3.8	52.6	3.8	61.8	4.1	68.7	6.4	76.2	6.4
8	12.7	22.1	54.6	3.8	58.9	3.8	68.1	4.1	75.1	6.4	82.6	6.4
12	19.1	28.4	61.0	3.8	65.3	3.8	74.5	4.1	81.4	6.4	88.9	6.4
16	25.4	34.8	67.3	3.8	71.6	3.8	80.8	4.1	87.8	6.4	95.3	6.4
20	31.8	41.1	73.7	3.8	78.0	3.8	87.2	4.1	94.1	6.4	101.6	6.4
24	38.1	47.5	80.0	3.8	84.3	3.8	93.5	4.1	100.5	6.4	108.0	6.4
28	44.5	53.8	86.4	3.8	90.7	3.8	99.9	4.1	106.8	6.4	114.3	6.4
32	50.8	60.2	92.7	3.8	97.0	3.8	106.2	4.1	113.2	12.7	120.7	12.7
36	57.2	66.5	99.1	3.8	103.4	3.8	112.6	4.1	119.5	12.7	127.0	12.7
40	63.5	72.9	105.4	3.8	109.7	3.8	118.9	9.5	125.9	12.7	133.4	12.7
44	69.9	79.2	111.8	3.8	116.1	9.5	125.3	9.5	132.2	12.7	139.7	12.7
48	76.2	85.6	118.1	9.5	122.4	9.5	131.6	9.5	138.6	12.7	146.1	12.7
52	82.6	91.9	124.5	9.5			138.0	9.5	144.9	12.7	152.4	12.7
56	88.9	98.3	130.8	9.5			144.3	9.5	151.3	12.7	158.8	12.7
60	95.3	104.6	137.2	9.5			150.7	9.5	157.6	12.7	165.1	12.7
64	101.6	111.0					157.0	9.5	164.0	12.7	171.5	12.7
68	108.0	117.3					163.4	9.5	170.3	12.7	177.8	12.7
72	114.3	123.7					169.7	9.5	176.7	12.7	184.2	12.7

## Head and Collar Dimension Table

Diameter (mm)	Head Dimensions		Collar Dimensions	
	B Max (mm)	C Max (mm)	K Max (mm)	L Max (mm)
12.7mm (1/2")	24.2	8.5	13.2	19.0
15.9mm (5/8")	30.4	11.0	16.4	23.7
19.1mm (3/4")	36.6	13.5	19.7	28.3
22.2mm (7/8")	42.3	14.9	22.9	33.0
25.4mm (1")	50.8	16.5	26.2	37.8

## Installed Dimensions

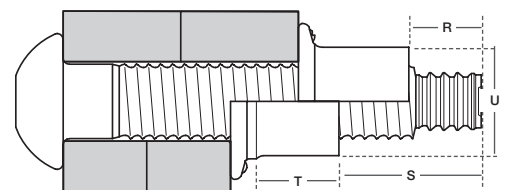

## Installed Information and Max Hole Table

Diameter (mm)	Minimum Installed Strength Values			Installed Dimensions				Max Hole (mm)
	Clamp (kN)	Tensile (kN)	Shear (kN)	R Min (mm)	S Max (mm)	T Min (mm)	U Max (mm)	
12.7mm (1/2")	53.6	75.8	62.3	10.9	23.7	14.4	18.4	14.3
15.9mm (5/8")	85.4	120.5	100.1	10.9	24.4	18	23.1	17.5
19.1mm (3/4")	126.3	178.4	144.1	13.6	27.9	21.6	27.7	20.6
22.2mm (7/8")	174.6	246.7	193.1	15.2	30.3	25.1	32	23.8
25.4mm (1")	229.1	323.4	251.3	17.4	33.2	29.2	36.9	28.6

# PART NUMBER CONSTRUCTION

Follow the form below to construct a part number for ordering BobTail pins and collars. Refer to the Grip Data chart for grip numbers.

## Small Diameter BobTail Pin (6,4 to 9,5mm)

**BT** (HEAD STYLE) - (MATERIAL) (DIAMETER) - (GRIP NUMBER) (FINISH)

Example: **BT-R8-4GA** is a BobTail LockBolt fastener, Round Head, Carbon Steel grade 5,8, 6,4mm (1/4") Diameter, Grip 4 (3,2 to 9,5mm), Zinc Electroplate.

HeadStyle	Suffix	Material	Suffix	Diameter	Suffix	Finish	Suffix
Round	No Letter	Carbon Steel Grade 5.8	R	6.4mm (1/4")	8	Zinc Electroplate	GA
Truss Head	98T	Carbon Steel Grade 8.8	BR	7.9mm (5/16")	10		
				9.5mm (3/8")	12		

Other Headstyles and materials available on request

## Large Diameter Imperial BobTail Pin (12,7 to 25,4mm)

**BT** (HEAD STYLE) - (MATERIAL) (DIAMETER) - (GRIP NUMBER) (FINISH)

Example: **BTR-BR16-4GA** is a BobTail LockBolt fastener, Round Head, Carbon Steel grade 8,8, 12,7mm (1/2") Diameter, Grip 4 (6,4 to 15,7mm), Zinc Electroplate.

HeadStyle	Suffix	Material	Suffix	Diameter	Suffix	Finish	Suffix
Round	R	BR	Carbon Steel Grade 8.8	12.7mm (1/2")	16	Zinc Electroplate	GA
				15.9mm (5/8")	20		
				19.1mm (3/4")	24		
				22.2mm (7/8")	28		
				25.4mm (1")	32		

Other Headstyles and materials available on request

## Small Diameter BobTail Collar (6,4 to 9,5mm) & Large Diameter Imperial BobTail Collar (12,7 to 25,4mm)

**BTC** (MATERIAL STRENGTH) - (MATERIAL) (DIAMETER) (FINISH)

Example: **BTC-R8GAH** is a Standard BobTail Collar, Low Carbon Steel, 6,4mm (1/4") Diameter, Zinc Electroplate.

Material Strength Grade	Suffix	Material	Suffix	Diameter	Suffix	Finish	Suffix
Low Carbon Steel	No Number	Carbon Steel	R	6.4mm (1/4")	8	Zinc Electroplate	GAH
Low Carbon Steel	5			7.9mm (5/16")	10		
				9.5mm (3/8")	12		
				12.7mm (1/2")	16	Zinc + Black*	BL*
				15.9mm (5/8")	20		
				19.1mm (3/4")	24		
				22.2mm (7/8")	28		
				25.4mm (1")	32		

Other collar types and materials available on request. Use suffix 5 collars to match with 8.8 grade pins

\* For 12.7mm collar stand finish is GAT (Zinc Electroplate)

## Large Diameter Metric BobTail Pin (12 to 20mm)

**MBT** (HEAD STYLE) - (MATERIAL) (DIAMETER) - (GRIP NUMBER) (FINISH)

Example: **MBT-DT12-10G** is a BobTail LockBolt fastener, Flanged Head, Carbon Steel grade 10.9, 12mm Diameter, Grip 10 (5 to 15mm), Mechanical Zinc.

HeadStyle	Suffix	Material	Suffix	Diameter	Suffix	Finish	Suffix
Flanged	No Letter	Carbon Steel Grade 10.9	DT	12mm	12	Mechanical Zinc	G
				14mm	14		
				16mm	16		
				20mm	20		

## Large Diameter Metric BobTail Collar (12 to 20mm)

**MBTC** - (MATERIAL) (DIAMETER) (FINISH)

Example: **MBTC-R16BL** is a Standard BobTail Collar, Low Carbon Steel, 16mm Diameter, Zinc + Black.

Material	Suffix	Diameter	Suffix	Finish	Suffix
Low Carbon Steel	R	12mm	12	Zinc + Black	BL
		14mm	14		
		16mm	16		
		20mm	20		

Other collar types and materials available on request

There are many different types of installation systems for the BobTail, dependent of fastener diameter, application type and application access. Some of the most popular tools are shown below but this is just part of our BobTail tooling range. Discuss your requirements with our dedicated systems team to find the optimum solution to suit your needs.

**To install BobTail the basic tooling requirement is:** **Installation Tool** – Either pneumatic or hydraulic **Nose Assembly** – To match with the fastener and tool **Powerig®** – To supply power to hydraulic tools **Additional Hose Set** – Sometimes required to connect hydraulic tools to the Powerig

**H** Hydraulic

**P** Pneumatic

**244BT/256BT** **P**



Diameters:  
244BT (6.4mm),  
256BT (7.9 -  
9.5mm)

The 244BT & 256BT Pneumatic Tools are specifically designed for rapid installation of BobTail.

**2480L** **H**



Diameters: 6.4mm

Hydraulic compact installation tool; high speed & high durability. Ideal for high volume production to install BobTail as well as other small diameter Lockbolts and structural blind rivets.

**2583** **H**



Diameters: 7.9mm & 9.5mm

Hydraulic installation with extra long stroke. Ideal for installing BobTail. Will also install other Lockbolts & structural blind rivets.

**2620-PT/2620** **H**



Diameters: 12mm & 12.7mm

Hydraulic installation tool, Installs BobTail as well as other 12mm & 12.7mm Lockbolts and the BOM® blind fastener.

**3585** **H**



Diameters: 12.7mm - 15.9mm - 16mm - 19.1mm

Hydraulic installation tool. Installs BobTail, other large diameter Lockbolts and BOM® structural blind rivets.

**HuckForce Advance HK32** **H**



Powerig; 3 phase electric, portable design. Can be used with all hydraulic installation tools.

**Swage Forward Tooling Series - SFBTT** **H**

**Hydraulic installation tool Principal of Operation**  
The operator pushes the tool with attached nose assembly over the end of the fastener until the tool puller bottoms on the fastener. When the trigger is pressed, the powerig receives a signal to swage the fastener. The piston moves forward to start the swaging process. After the fastener is fully swaged, the operator must release the trigger, at which point the nose assembly anvil is ejected off of the collar and the tool is released from the fastener.

**SFBTT8** **H**



Diameters: The SFBTT8 will install 6.4mm, 7.9mm and 9.5mm BobTail fasteners.

Hydraulic installation tool, Installs BobTail; for tight, space-constrained applications the SFBTT8 allows the operator to position their hand at a safe distance from the working structure during installation..

**SFBTT15** **H**

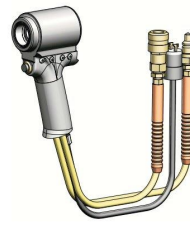

Diameters: SFBTT15 will install 12mm, 1/2" and 14mm BobTail fasteners.

The SFBTT series, makes the installation process quicker and easier by reducing the force required to install each fastener. Compact and light weight production tools, these swage forward tools give the operator great flexibility as well as extended reach into difficult areas. For tight, space-constrained applications the SFBTT8 allows the operator to position their hand at a safe distance from the working structure during installation.

**SFBTT20** **H**



Diameters: The SFBTT20 will install 12mm, 12.7mm, 14mm, 15.9mm and 16mm BobTail fasteners.

**SFBTT46** **H**



Diameters: The SFBTT46 will install both 22.2mm and 25.4mm BobTail fasteners

## HK34-001/115 (110V AND 230V)



Powerig; available in 110v and 230v - electric, portable design. Can be used with all hydraulic installation tools.

The Powerig hydraulic Directional Valves plus control circuits, are powered from a 24 Volt DC remote circuit activated by the Tool Trigger.

Huck Installation Tools are connected to the Powerig by means of Pull & Return Hydraulic Hoses and an Electrical Control Cord fitted with connectors.

The functions of the Motor/Pump and hydraulic valves are controlled by the Tool Trigger during fastener installation. The Tool Trigger is depressed to start the installation sequence. The Powerig Motor/Pump will start (if it is not already running in the idle mode), and the Tool Piston/Nose Assembly will move to start the Fastener Installation cycle.

Depending on the type of Tool used and the Fastener being installed, the Tool Piston/Nose Assembly will automatically return to their original start positions when the operator releases the Tool Trigger. The Powerig Motor/Pump will then stop once the tool piston is in the fully forward (returned) position.

## Installation Gauges



Easy to use ring gauge used to ensure each installation is correct.

## BobTail Removal



A quick change of nose assembly from the installation nose to the cutter nose enables removal of BobTail fasteners using the same tooling system.

# HOW IT WORKS

## How BobTail Works

**Clamp Force or Pre-Load:** In the initial stages of the installation process, the tool engages and pulls on the tail of the fastener. The joint is pulled together before the anvil portion of the nose assembly is forced down the collar. This progressively locks (swages) it into the grooves of the harder pin. The pin and swaged collar combine to form the installed fastener.

The squeezing action reduces the diameter of the collar, increasing its length. This in turn stretches the pin, generating a clamp force over the joint.

**Shear strength of BobTail fasteners** vary according to the material strength and minimal diameter of the fastener. By increasing the diameter or the grade of material, the shear strength of the fastener can be increased.

**The tensile strength of BobTail fasteners** is dependent on the shear resistance of the collar material and the number of grooves it fills.



BobTail HuckBolts also available in thread-head configuration for limited clearance applications.

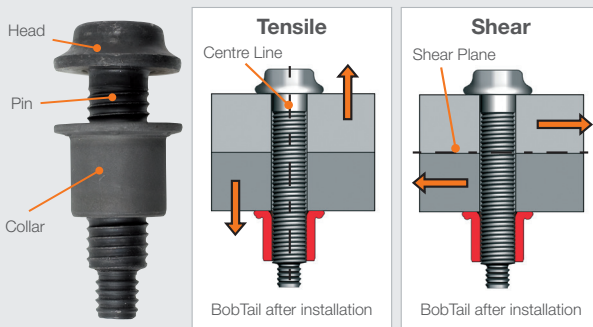

# CONTACT

Howmet Fastening Systems  
Telford Operations,  
Unit C, Stafford Park 7  
Telford  
TF3 3BQ  
England  
Tel: +44 (0) 1952 290011  
Fax: +44 (0) 1952 204670  
Email:  
enquiries@hfsindustrial.com Web:  
www.hfsindustrial.com

Howmet Fastening  
Systems Kelkheim  
Operations, Industriestr. 6  
65779 Kelkheim  
Germany  
Tel : +49 (0) 6195-805-0  
Fax : +49 (0) 6195-2001



The UK's largest Huck Distributor

**Star Fasteners (UK) Ltd**  
**Unit 1, 44 Brookhill Road,**  
**Pinxton,**  
**Nottinghamshire**  
**NG16 6RY**  
**United Kingdom.**

**sales@starfasteners.co.uk | Tel: +44(0)1159324939**

Howmet Fastening Systems  
Cosme Operations,  
9 rue de Cressonnières  
72110 Saint Cosme en Valrais  
France  
Tel : +33 (0) 2.43.31.41.00  
Fax : +33 (0) 2.43.31.41.41

#### Disclaimer:

The information contained in this publication is only for general guidance with regard to properties of the products shown and/or the means for selecting such products, and is not intended to create any warranty, express, implied, or statutory; all warranties are contained only in HFS's written quotations, acknowledgments, and/or purchase orders. It is recommended that the user secure

HFS HB02 0615

© 2020 Howmet Aerospace Inc. and / or its subsidiaries. All rights reserved.



The mark of responsible forestry  
Cert. no. IT-COC-002844  
© 1996 Forest Stewardship Council

